

1年生女子

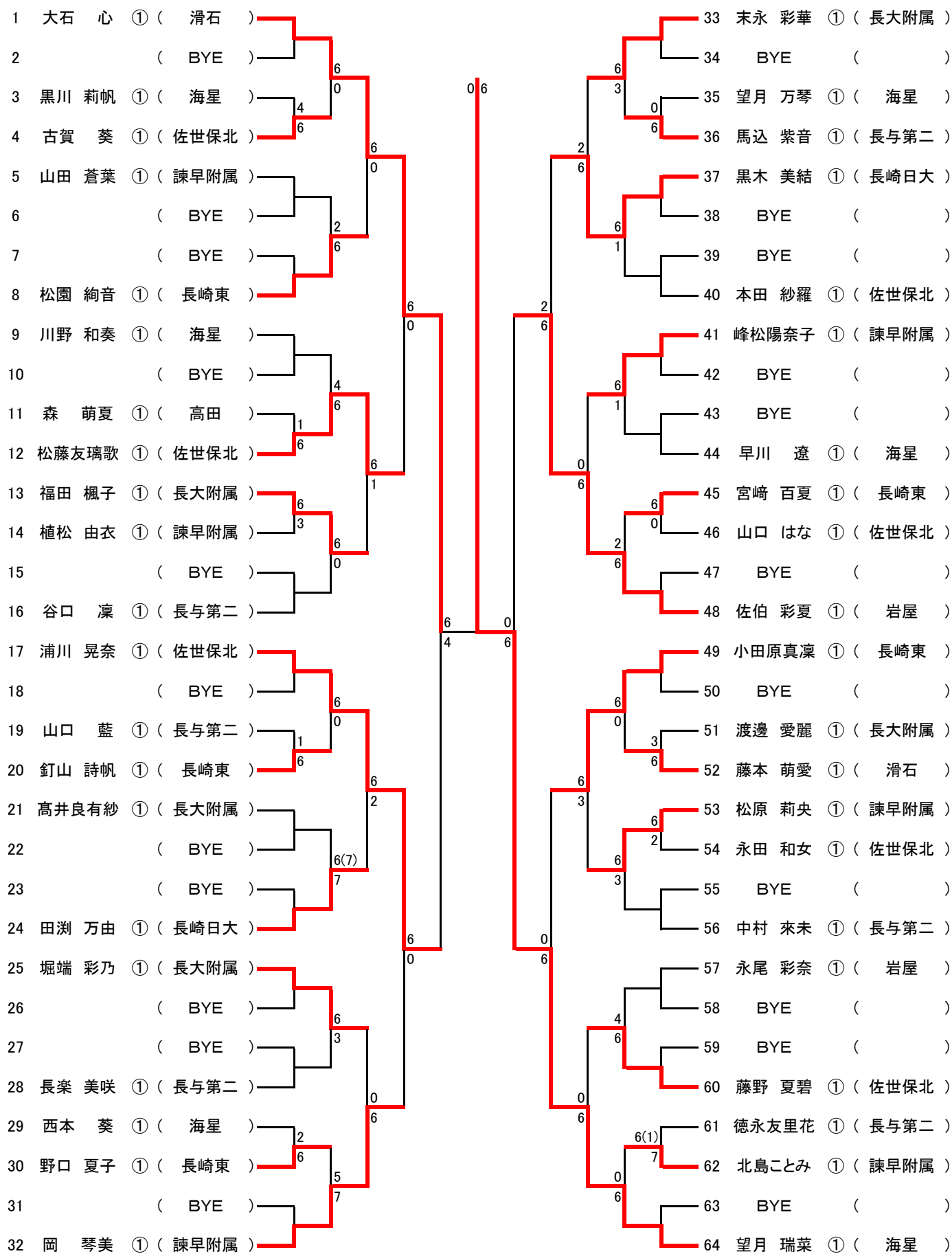

2年生女子

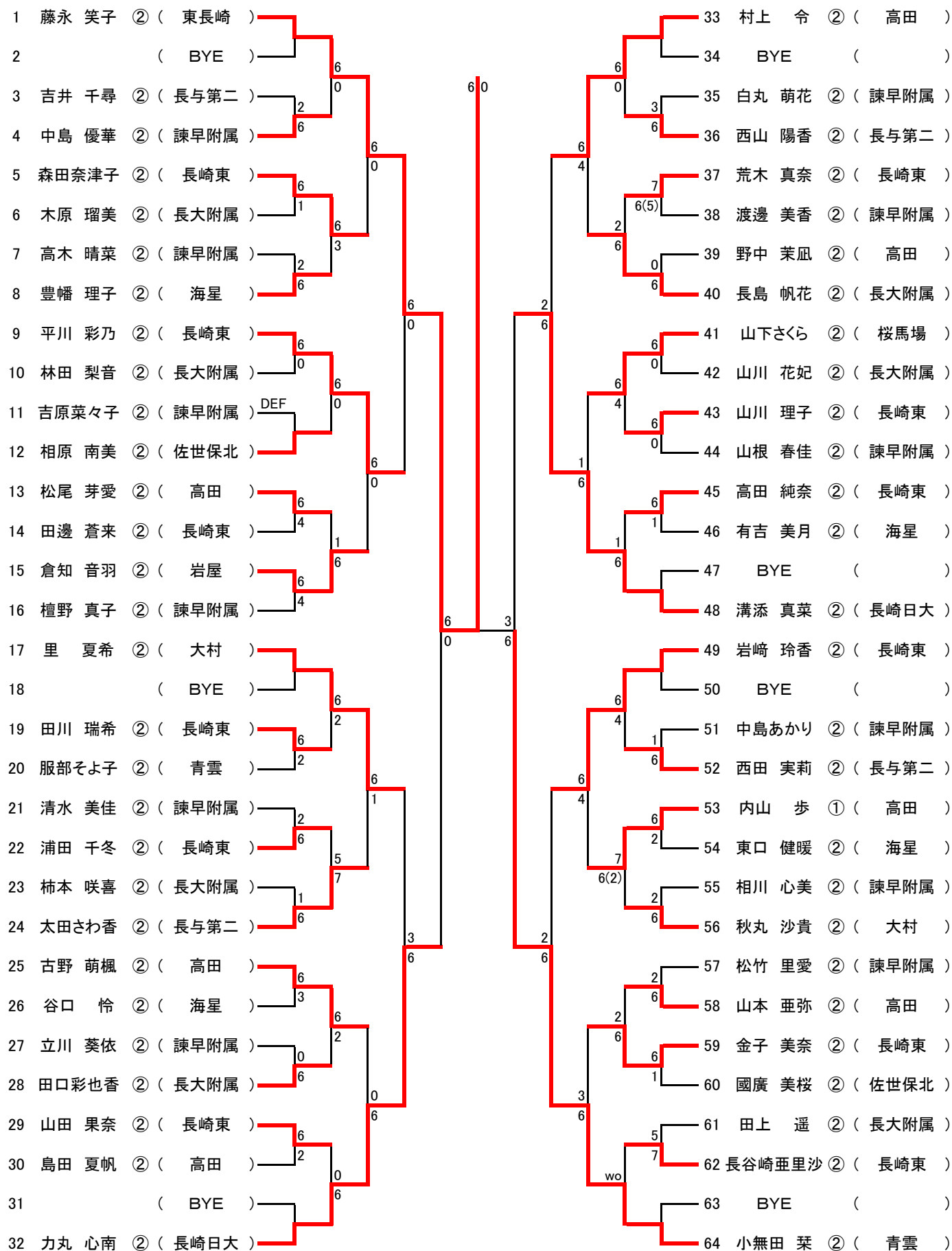

2年男子順位決定戦

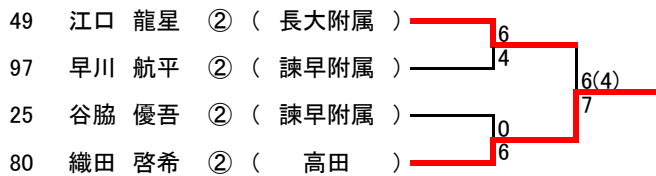

2年男子3位

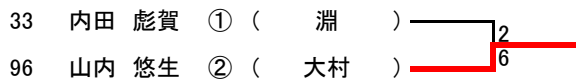

2年女子順位決定戦

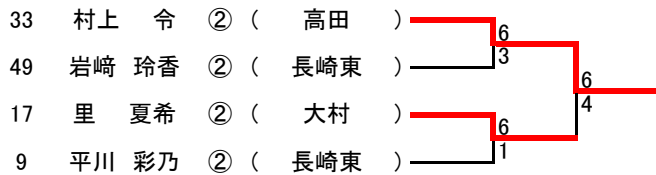

2年女子3位

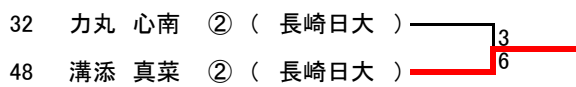

1年男子順位決定戦

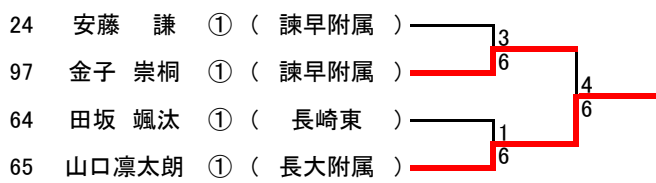

1年男子3位

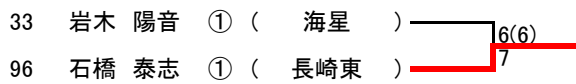

1年女子順位決定戦

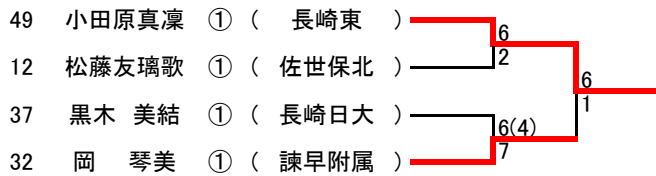

1年女子3位

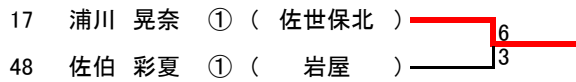

7位

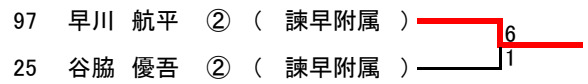

7位

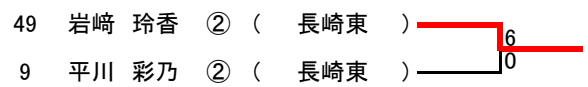

7位

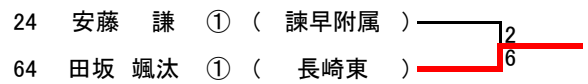

7位

